

A History of Television

**by Jean-Jacques Peters
(EBU)**

Contents

[Preface](#)

[The foundations](#)

[The first broadcasts](#)

[Highlights](#)

[Colour television](#)

[On the primaries](#)

[Colour television
transmission](#)

[Digital television](#)

[Technological developments](#)

[Television cameras](#)

[Television film
scanning](#)

[Video recording](#)

[Electronic special effects](#) [Digital images](#)

[Towards other screens](#)

Preface

Did you know there are more television sets in the world than there are telephones? Even the television professionals find it hard to believe. However the statistics prove it to be true; according to official figures from the International Telecommunication Union there were 565 million telephones in 1983, and 600 million television sets. Other figures are just as impressive: in Belgium, from 1967 to 1982, the average time spent watching television by children from 10 to 13 years, increased from 82 to 146 minutes per day. Stupefying in every sense of the word.

Our senses are assailed every day by the attraction of the visual message. Its all-pervasiveness and instantaneity are finely tuned to our way of thinking, whether we be hard-pressed or lazy. We expect from it effortless pleasure and hot news. A Chinese proverb tells us a picture is worth ten thousand words.

But the stupefaction takes its toll and we thirst for more. Images pour over us in a never-ending torrent.

Television has already modified our social behaviour. It fosters, for example, our taste for things visual the impact of the picture and its colours. It encourages in us a yearning for the big spectacle the razzmatazz and the forthright declaration. The effect can be seen in the way we react one to another and in the world of advertising. But television cannot yet be said to have enriched our civilisation. For that to happen it must become interactive, so the viewers may cease to be just absorbers.

In the flood of images from the silver screen the less good accompanies the best, just as in the cinema or in literature. The factor which distinguishes television from the cinema and books, however, is that the full quality range, down to the very worst, is offered to us round the clock, in our own homes. Unless we take particular care to preserve our sense of values, we let it all soak in. We have not yet become "diet conscious", as regards our intake of television fare, although this is becoming increasingly necessary as the number of chains available to the public steadily increases. Without this self-control our perception becomes blurred and the lasting impression we have ceases to be governed by a strict process of deliberate reflection.

Television cannot, on its own, serve as an instrument of culture. It has, to be appreciated that it is not well-suited for detailed analysis or in-depth investigation. The way it operates and its hi-tech infrastructure are such that it cannot do justice to the words of the poet. How fortunate that there are other media for that.

Television aims at our most immediate perception. Pictures to see almost to feel. It is a medium for multiple contact; it sets the whole world before us. It offers us entertainment games, sports and more serious programmes news. Eurovision was created for that very purpose. Television offers something of everything, and each viewer can pick and chose whatever he or she finds the most enlightening.

The cultivation of a diet-conscious viewing public will be easier if the viewers can become more familiar with the media and how they work if we can do away with the "telly" myth. Some attempts have already been made. The 50th anniversary of television affords an excellent opportunity to contribute to this movement and, by showing equipment and drawings, we hope to enlighten our visitors about the workings of this most consumed of consumer technologies.

This brochure will bring them closer still to understanding what happens behind the television screen. We have made every effort to make the essential features of television understandable to visitors without specialised scientific knowledge. We have restricted ourselves to aspects likely to be of particular interest to viewers, concentrating on systems or organisations which the public know to exist, but of which they have only a very meagre understanding.

We hope, therefore, that this brochure, like the exhibition it accompanies, will serve to bring the public and the media a little closer.

- **Jean-Jacques Peters** (EBU), Brussels 1985

A few words on history

For ages Man dreamt about the possibility of transmitting pictures over great distances, but not until he had learnt to master the electron was there any real hope of turning dream into practical reality.

And it all happened by chance...

The foundations

1873. Ireland. A young telegraph operator, **Joseph May**, discovered the photoelectric effect: selenium bars, exposed to sunlight, show a variation in resistance. Variations in light intensity can therefore be transformed into electrical signals. That means they can be transmitted.

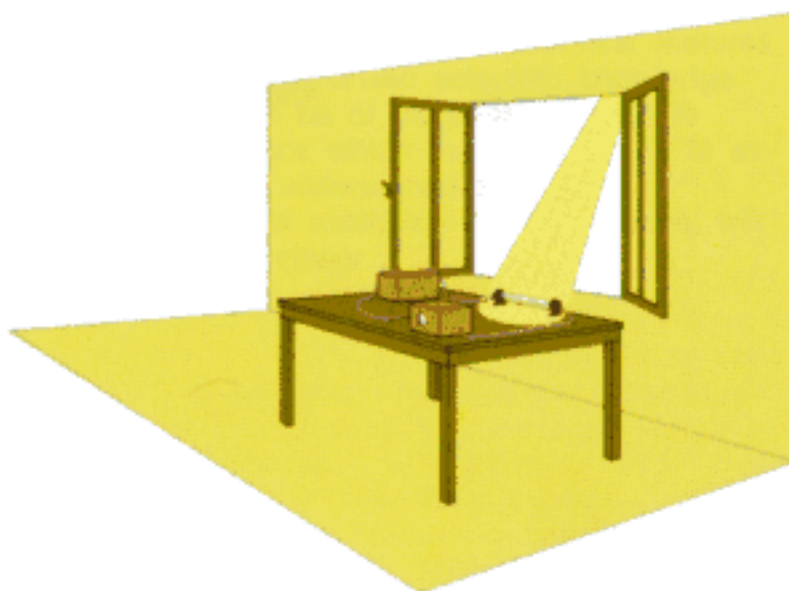

The photoelectric effect

1875. Boston, USA. **George Carey** proposed a system based on the exploration of every point in the image simultaneously: a large number of photoelectric cells are arranged on a panel, facing the image, and wired to a panel carrying the same number of bulbs.

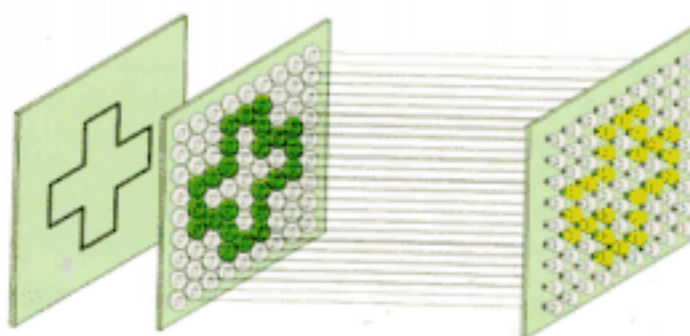

George Carey's idea

This system was impracticable if any reasonable quality criteria were to be respected. Even to match the quality of cinema films of that period, thousands of parallel wires would have been needed from one end of the circuit to the other.

In France in 1881, **Constantin Senlecq** published a sketch detailing a similar idea in an improved form: two rotating switches were proposed between the panels of cells

and lamps, and as these turned at the same rate they connected each cell, in turn, with the corresponding lamp. With this system, all the points in the picture could be sent one after the other along a single wire.

This is the basis of modern television: the picture is converted into a series of picture elements. Nonetheless, Senlecq's system, like that proposed by Carey, needed a large number of cells and lamps.

1884, the German **Paul Nipkow** applied for a patent covering another image scanning system: it was to use a rotating disk with a series of holes arranged in a spiral, each spaced from the next by the width of the image; a beam of light shining through the holes would illuminate each line of the image.



Paul Nipkow (1860-1940)

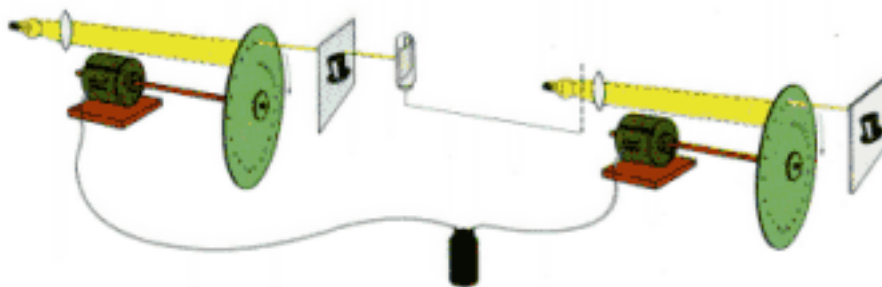

Nipkow's System

The light beam, whose intensity depended on the picture element, was converted into an electrical signal by the cell. At the receiving end, there was an identical disc turning at the same speed in front of a lamp whose brightness changed according to the received signal.

After a complete rotation of the discs, the entire picture had been scanned. If the discs rotated sufficiently rapidly, in other words if the successive light stimuli followed quickly enough one after the other, the eye no longer perceived them as individual picture elements. Instead, the entire picture was seen as if it were a single unit.

The idea was simple but it could not be put into practice with the materials available at the time.

Other scientific developments were to offer an alternative. The electron, the tiny grain of negative electricity which revolutionised physical science at the end of the 19th century, was the key. The extreme narrowness of electron beams and their absence of inertia caught the imagination of many researchers and oriented their studies towards what in time became known as electronics. The mechanical approach nevertheless stood its ground, and the competition lasted until 1937.

The cathode ray tube with a fluorescent scene was invented in 1897. **Karl Ferdinand Braun**, of the University of Strasbourg, had the idea of placing two electromagnets around the neck of the tube to make the electron beam move horizontally and vertically. On the fluorescent screen the movement of the electron beam had the effect of tracing visible lines on the screen.

A Russian scientist, **Boris Rosing**, suggested this might be used as a receiver screen and conducted experiments in 1907 in his laboratory in Saint Petersburg.

As early as 1908 the Scotsman **A. A. Campbell Swinton** outlined a system using cathode ray tubes at both sending and receiving ends. This was the first purely electronic proposal. He published a description of it in 1911 :

- the image is thrown onto a photoelectric mosaic fixed to one of the tubes;
- a beam of electrons then scans it and produces the electric signal;
- at the receiving end, this electric signal controls the intensity of another beam of electrons which scans the fluorescent screen.



A. A. Campbell-Swinton (1863-1930)

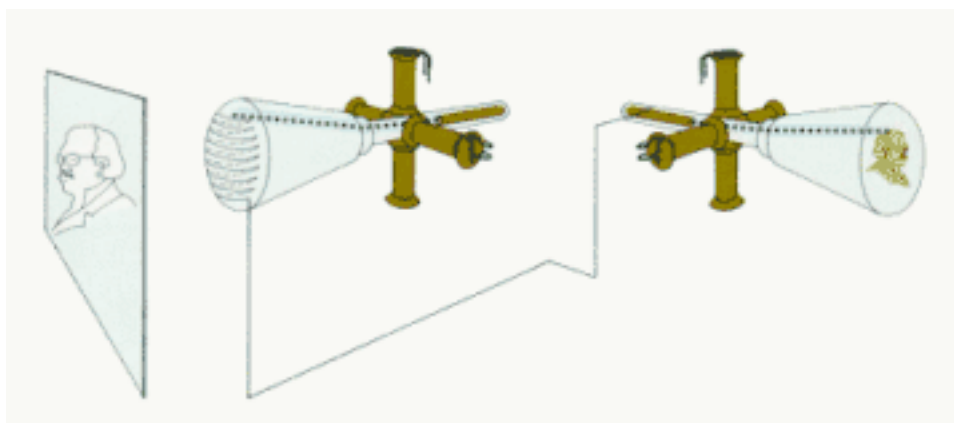

The first purely electronic proposal

The methods proposed by Nipkow and Campbell Swinton were at the time theoretical ideas only. The available cells were not sensitive enough and they reacted too slowly to changes in light intensity. The signals were very weak and amplifiers had not yet been invented.

On the word "television"

The names given to the first systems, at the end of the 19th century, highlighted the form of energy used for transmission; names such as "télectroscope" and "electrical telescope" were used.

The German word "Fernsehen" was first used in 1890, by the physicist **Eduard Liesegang**. This became "fjer-syn" in Danish.

The French word "télévision" was used for the first time in 1900 by the Russian physicist **Constantin Perskyi** who delivered a speech on the subject during the great Paris exhibition. "télévision" caught on, and it became "television". in English, "televisie" in Dutch, "televisione" in Italian, "television" in Spanish, etc.

On the electron

The electron is a corpuscle of admirable lightness and sensitivity. Weak electric fields are sufficient to give it enormous speed and, once it is moving, its direction remains easily influenced by electric and magnetic fields through which it passes and whose action readily curves its trajectory.

There exists an apparatus which illustrates the flexibility of the electron especially well: this is the old "Braun tube" which, following improvements, has become the cathode-ray oscilloscope. This admirable instrument follows with extreme sensitivity and without inertia the variations of an electric voltage. It has innumerable applications and television, which requires the ultra-rapid scanning of an image, could scarcely do without this precious help.

- **Louis de Broglie**, French physicist, Nobel prize-winner,
1929.

But science marched on. There was the potassium cell, which reacted much more rapidly than the selenium cell. Then came the triode, manufactured in large quantities from about 1915, the development of which owed much to the new-born "wireless". There was also the neon lamp, whose light intensity could be varied rapidly, making it suitable for use in disc receivers.

It was Nipkow's ideas which were the first to benefit from these inventions, and were the first to become practical realities.

In 1925, an electrical engineer from Scotland, **John Logie Baird**, exhibited in Selfridges department store in London an apparatus with which he reproduced a simple image, in fact white letters on a black background, at a distance. It was not really television because the two discs which served to transmit the image and to reproduce it, were mounted on the same shaft. However Baird did effectively demonstrate that the principle of successive scanning could be applied in practice. He did it again in 1926, in his laboratory, with the first transmission of a real scene the head of a person. The picture was scanned in 30 lines, with 5 full pictures every second.

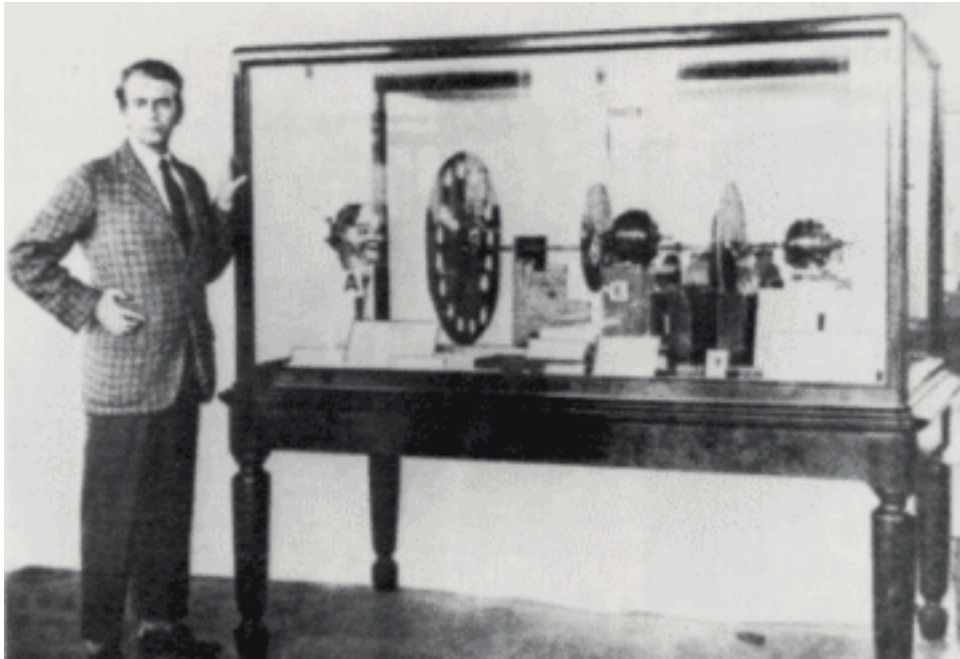

John Logie Baird and his television apparatus in 1926

Similar machines were built in Germany. A smaller mechanical apparatus was presented at the Berlin Radio Show in 1928 by **Denes von Mihaly**. It was called the "Telehor",. Here too the picture was scanned with 30 lines, but at a picture rate of 10 frames/second.

In France, some time later, the "Semivisor" appeared. It also used 30-line scanning and was built by **René Bartholemy**.



René Bartholemy (1889-1954)

It was about this time that the first tests with the radio-electric transmission of television took place, using the medium-wave radio band.

These transmissions attracted the attention of many amateur enthusiasts who built their own disc receivers. The public slowly became aware of the research that was under way.

Manufacturers joined in the new adventure, organising systematic studies in their laboratories. New companies were born, such as "Fernseh" in Germany (1929).

But what happened to Rosing's experiments? Had everyone forgotten them?

In fact many researchers kept his work in mind but they had to wait for developments in the design of cathode-ray tubes before these could be put to any practical use.

Around 1930, a number of researchers independently developed the principle of interlaced scanning, which involves exploring first all the odd-numbered lines, followed by the even-numbered lines; this technique avoids flicker.

Industry developed techniques to achieve a very great vacuum in tubes. Receivers with cathode-ray tubes came onto the market in 1933.

However, the use of cathode-ray tubes at the transmission source, where the picture was scanned, remained the stumbling-block for many years. Initially, the spot of light produced on the fluorescent screen was made to substitute for the light beam in the Nipkow system. In Germany, **Manfred von Ardenne** built the first "flying spot" cathode-ray tube, thereby enabling transparencies to be scanned. A complete transmission system was presented at the 1931 Berlin Radio Show. This scanning method was subsequently used for all television films.

The process nonetheless posed enormous problems when applied to real scenes because the light beam had to operate in a darkened environment. Outdoor scenes, for example, were totally impossible. Another process, known as the "intermediate film" system, provided a roundabout solution to this problem for a number of years. Scenes were shot on film, and this was immediately developed and scanned by a disc or flying spot scanner.

The solution to the problem of out-door shooting came from across the Atlantic.

Following up an idea he had had in 1923, **Vladimir Zworykin** (one of Rosing's assistants who had emigrated to the United States) invented the "Iconoscope". This was a globe-shaped cathode-ray tube and it contained the first photoelectric mosaic made from metal particles applied to both sides of a sheet of mica.



Vladimir Zworykin (1889-1982)

This first camera tube was more compact than the disc, easier to use and more sensitive. The electron beam, which "visits" the elements of the mosaic at a considerable speed, collects from each point all the photoelectric charge which has

accumulated there since the last visit, whereas in the mechanical systems the photoelectric cell receives the light from each point only during the very short period while it is actually being scanned.

Zworykin presented the first prototype iconoscope at a meeting of engineers in New York in 1929. The apparatus was built by RCA in 1933. It scanned the image in 120 lines, at 24 frames/second.

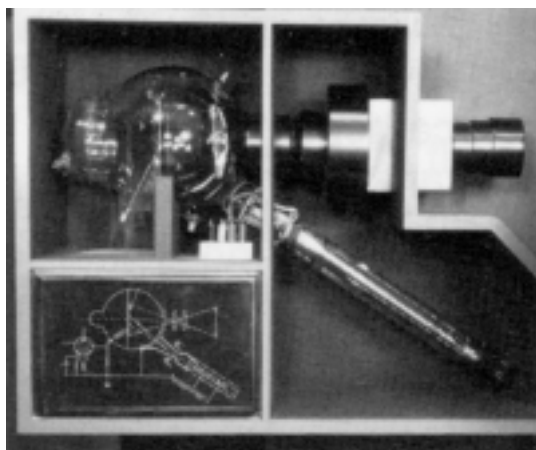

The first iconoscope

Progress was then rapid: as early as 1934, 343-line definition had been achieved and interlacing was being used.

In England, **Isaac Schoenberg** (another Russian emigrant and childhood friend of Zworykin) led developments in the EMI company on a camera tube similar to the iconoscope. This was the Emitron and it had certain advantages over its rival. EMI, too, adopted interlacing. Also, as early as 1934, EMI. Schoenberg was aiming at a greater number of lines than RCA the target was 405 lines.



Isaac Schoenberg

The system of mechanical analysis, based on the Nipkow disk, nevertheless continued to hold favour with some.

In 1929, Baird convinced the BBC that it ought to make television transmission outside normal radio programme hours using a 30-line system giving 12½ frames per second. He marketed his first disc receivers, known as "televisors". He steadily

improved his equipment, increasing the scanning to 60, 90, 120 and even 180 lines.

In France, René Bartholemy embarked on the development of a particular variant of the disc. During 1931, he gave two demonstrations, which brought him considerable renown, involving 30-line transmission and reception.

Bartholemy's system, which had been tried by certain German engineers, had a mirror drum instead of a disc with holes. The mirrors, which served to illuminate the subject with light from a bright source, were inclined to an increasing degree with respect to the drum axis. They therefore scanned the subject in a series of parallel lines. Potassium cells collected the light reflected from the subject.

Baird, too, built similar systems. However the mirror drum was bulky and was unsuitable for the high speeds that had to be used to achieve a large number of lines. It was therefore abandoned in 1933 and work on Nipkow disc systems was resumed.

The first broadcasts

March 1935. A television service was started in Berlin (180 lines/frame, 25 frames/second). Pictures were produced on film and then scanned using a rotating disk. Electronic cameras were developed in 1936, in time for the Berlin Olympic Games.



An "iconoscope" camera, Berlin Olympics, 1936

November 1935. Television broadcasting began in Paris, again using a mechanical system for picture analysis (180 lines/frame, 25 frames/second).



The first studio in Paris

That same year, spurred on by the work of Schoenberg, the EMI company in England developed a fully electronic television system with 405-line definition, 25 frames/second, and interlace.

The Marconi Company provided the necessary support regarding the development of transmitters.

The British government authorised the use of this standard, along with that of Baird, for the television service launched by the BBC in London in November 1936 (the Baird system used mechanical scanning, 240 lines, 25 frames/second and no interlace). The two systems were used in turn, during alternate weeks.

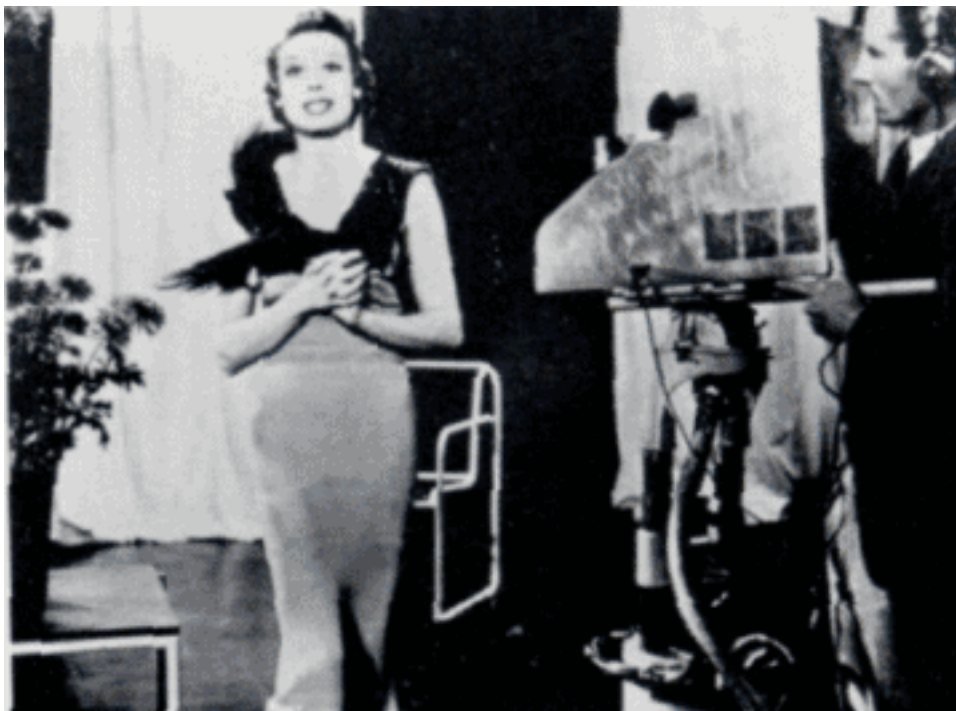

Adele Dixon opening the BBC service with a specially written song "Television".

The 240-line mechanical scanning system pushed the equipment to the limit and

suffered from poor sensitivity. The balance thus swung in favour of the all-electronic 405-line system which was finally adopted in England in February 1937.

The same year, France introduced a 455-line all-electronic system.

Germany followed suit with 441 lines, and this standard was also adopted by Italy. The iconoscope was triumphant. It was sensitive enough to allow outdoor shooting. It was by means of a monster no less than 2.2 m long, the television canon, (in fact an iconoscope camera built by Telefunken) that the people of Berlin and Leipzig were able to see pictures from the Berlin Olympic Games. Viewing rooms, known as Fernsehstuben were built for the purpose.

Equipment that was easier to manipulate was used by the BBC for the coronation of His Majesty King George VI in 1937 and, the following year, for the Epsom Derby. Public interest was aroused. From 1937 to 1939 receiver sales in London soared from 2 000 to 20 000.

Research in the United States (Zworykin and the RCA company) bore fruit at about the same time. The first public television service was inaugurated in New York in 1939 with a 340-line system operating at 30 frames/second.

Two years later, the United States adopted a 525-line 60 frames/second standard.

The first transmitters were installed in the capital cities (London, Paris, Berlin, Rome, New York) and only a small proportion of the population of each country was therefore able to benefit. Plans were made to cover other regions.

The War stopped the expansion of television in Europe. However the intensive research into electronic systems during the War, and the practical experience it gave, led to enhancements of television technology. Work on radar screens, for example, benefited cathode-ray tube design; circuits able to operate at higher frequencies were developed.

When the War was over, broadcasts resumed in the national standards fixed previously: 405 lines in England, 441 lines in Germany and Italy, 455 lines in France. Research showed the advantages of higher picture definition, and systems with more than 1000 lines were investigated. The 819-line standard emerged in France.

It was not until 1952 that a single standard (625 lines, 50 frames/second) was proposed, and progressively adopted, for use throughout Europe. Modern television was born.

Highlights

It is difficult to summarise the developments in television since the 1950s.

Of course picture sources have become more sensitive. New equipment has made its appearance. There were two innovations however which introduced radical change

and whose effects were felt not only in the way television programmes are made but also in the way in which they were perceived by the viewer: these were the arrival of colour and the introduction of digital technologies.

Colour television

The physical concept allowing the reproduction of colour is **metamerism**: the effect of any colour on the human eye can be reproduced by combining the effects of three other colours, known as primaries. Three simple colours can constitute primaries if none can be achieved with a combination of the other two.

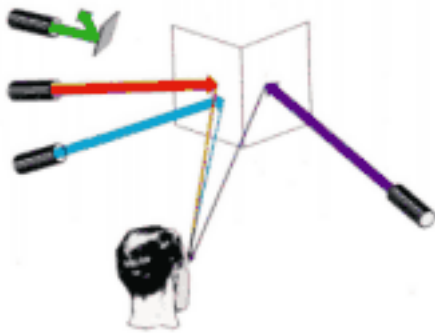

Red plus Blue

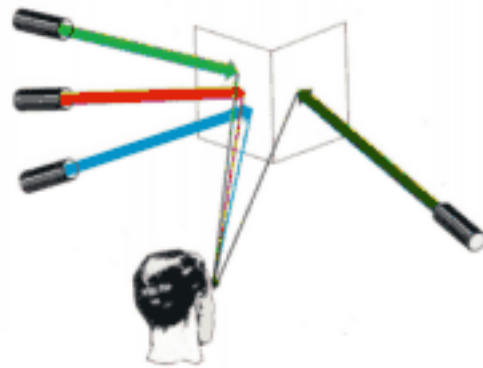

Green plus Red plus Blue

In practice, we use red, green and blue, since this trio can match the greatest range of natural colours. In other words, we can define any colour by indicating the proportion of red, green and blue which have to be used for its reconstitution.

In physical terms, a colour corresponds to a series of electromagnetic radiations of different wavelengths. As primaries, we can select radiations of a single wavelength (monochromatic) or groups of several different wavelengths (polychromatic). The primaries used in modern television sets are quasi-monochromatic.

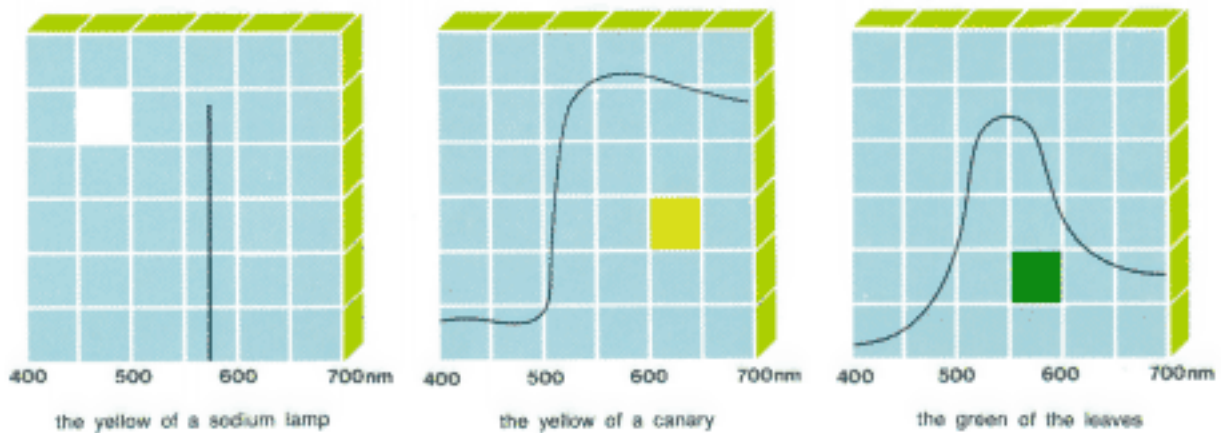

Quasimonochromatic primaries

The primaries used in television result from a compromise between the range of colours to be reproduced and what can in fact be manufactured with the available

luminescent materials.

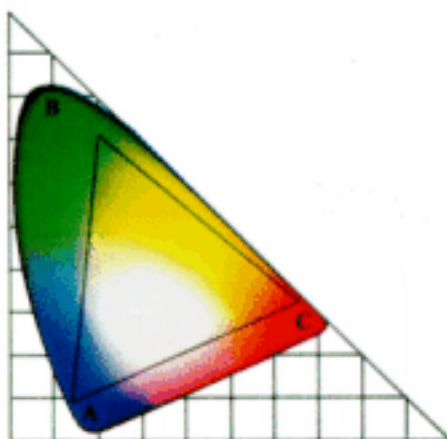

Television colour triangle

On the primaries

The triple nature of colour derives from a characteristic of human physiology, since colour vision depends on the absorption of light, by the retina of the eye, by three different photosensitive pigments.

The practical experience showing that three colours can, when brought together, equal a fourth, indicates that this principle can serve as the basis for colour reproduction. Experience shows also that the greater the differences between the three primaries, the greater will be the variety of colours that can be reproduced. That is why the primaries in traditional use are very saturated red, green and blue. These are the "analysis primaries".

To transmit the corresponding electrical signals in the best possible way it is desirable to combine them to give three different signals. One represents the values of picture brightness (luminance) and the other two, taken together, represent the purely chromatic values of the picture. These are the "transmission primaries".

In the camera, the colour is decomposed into primaries by means of prisms. Each primary illuminates a separate tube and therefore produces its own signal.

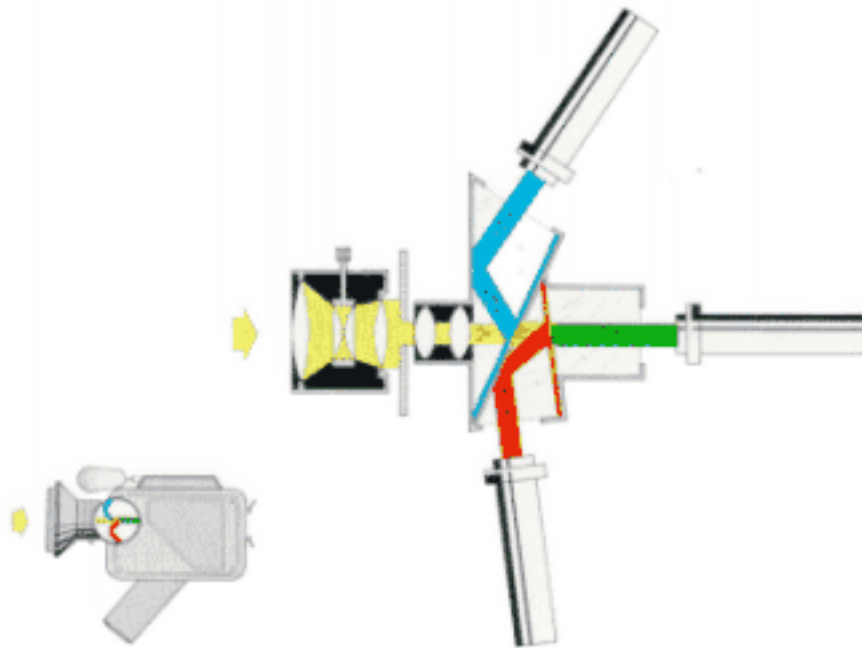

In the camera

In receivers, the colour is reconstituted using a large number of luminescent spots arranged in red-green-blue triplets. The spots are close enough so that, from a reasonable viewing distance, a triplet appears as a single information source. In other words, the eye sees each triplet as one picture element.

The number of discernible colours, with television primaries, is around ten thousand.

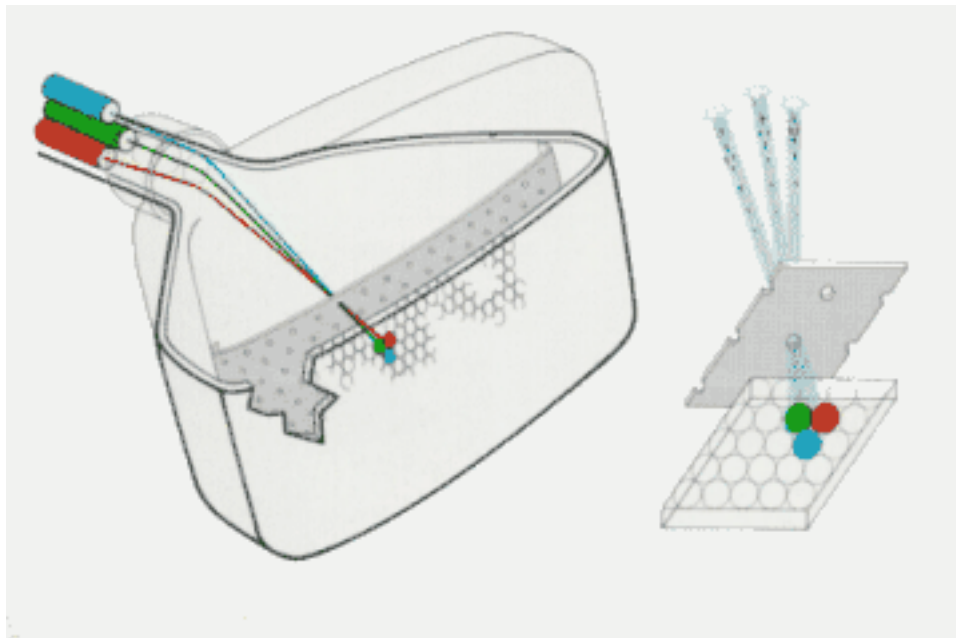

In the receiver

The red, green and blue primaries are only used in the camera and receiver. Between these, the constraints imposed by practical transmission systems are such that they must be cunningly converted into a different form, as we shall see.

Colour television transmission

The first practical demonstration of colour television was given back in 1928 by Baird; he used mechanical scanning with a Nipkow disk having three spirals, one for each primary. Each spiral was provided with a separate set of colour filters. In 1929, **H.E. Ives** and his colleagues at Bell Telephone Laboratories presented a system using a single spiral through the holes of which the light from three coloured sources was passed; the signal for each primary was then sent over a separate circuit.

As 1940 approached, only cathode-ray tubes were envisaged, at least for displaying the received picture.

In 1938, **Georges Valensi**, in France, proposed the principle of dual compatibility:

- programmes transmitted in colour should also be received by black and white receivers
- programmes transmitted in black and white should also be seen as black and white by colour receivers

In 1940, **Peter Goldmark**, of CBS in and the United States, demonstrated a sequential system for transmitting three primaries obtained using three colour filters placed in the light path before scanning.

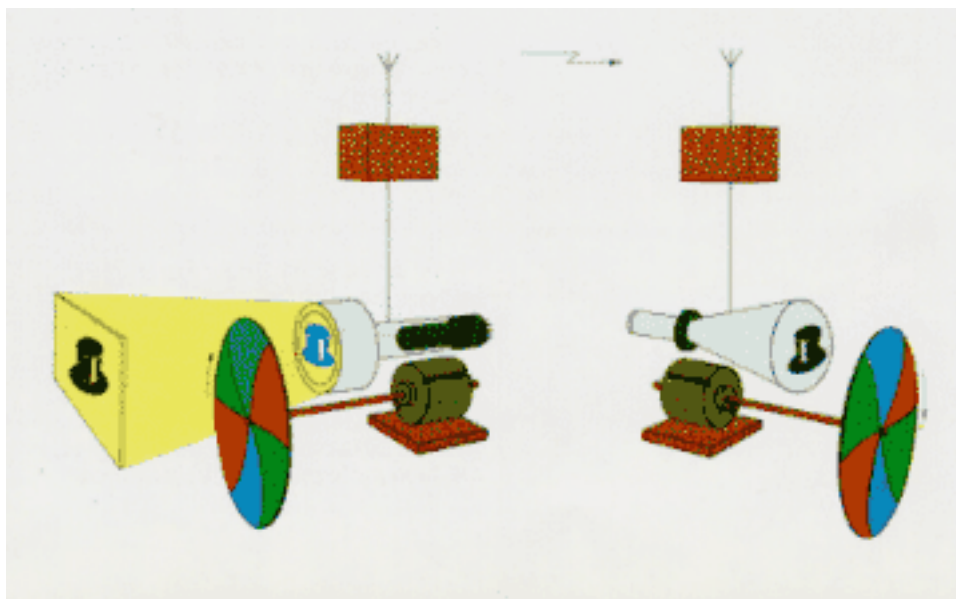

Goldmark's sequential three-filter system

The system was barely practicable. In addition, it required three times as large a range of frequencies (i.e. band-width) as compared to black-and-white transmission. Other researchers were looking for a non-mechanical solution which would not require such a large bandwidth.

In 1953, simultaneous research at RCA and the Hazeltine laboratories, in the United States, led to the first compatible system. This was standardised by the National Television System Committee, made up of television experts working in industry,

and is known as the National Television Systems Committee (NTSC) system.

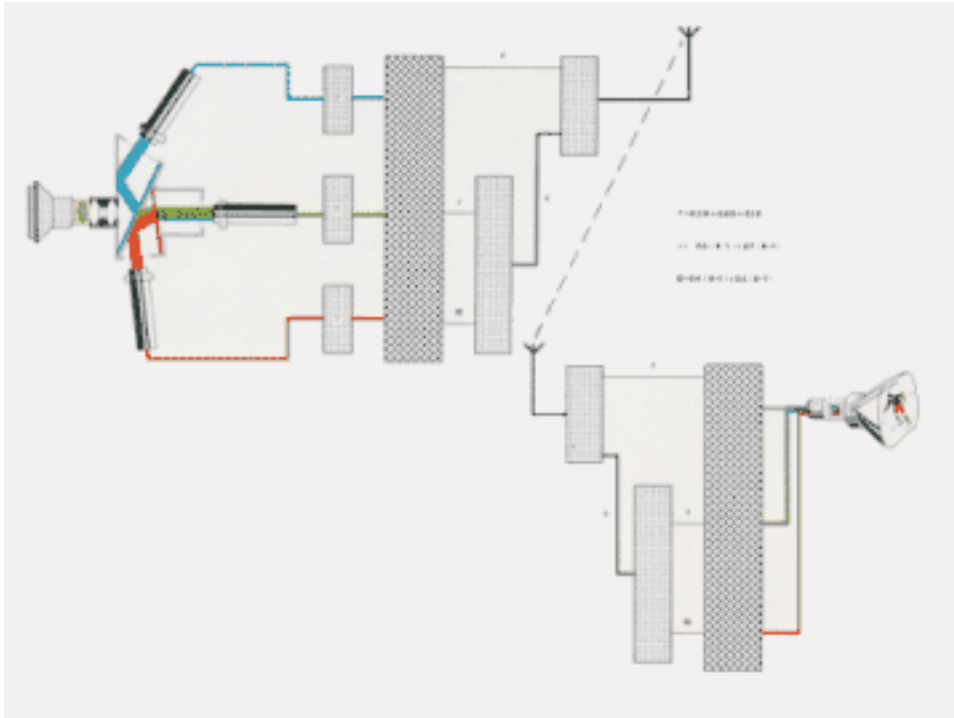

The NTSC system

The signal is no longer transmitted in the form of three primaries, but as a combination of these primaries. This provides a "luminance" signal Y which can be used by black and white receivers. The colour information is combined to constitute a single "chrominance" signal C. The Y and C signals are brought together for transmission.

The isolation of the chrominance and luminance information in the transmitted signal also allows bandwidth savings to be made. In effect, the bandwidth of the chrominance information can be made much smaller than that for the luminance because the acuity of the human eye is lower for changes of colour than it is for changes of brightness.

The visual appearance of a colour can be defined in terms of three physical parameters for which words exist in our everyday vocabulary:

- the hue (which is generally indicated by a noun)
- the saturation (indicated by an adjective, with the extreme values referred to as "pure" colour and "washed-out" colours)
- the brightness or lightness (also indicated by an adjective, the extremes here being "bright" colours and "dark" colours).

The compatible colour television signal is made up in such a way as to ensure that these parameters are incorporated.

The amplitude of the C signal corresponds to the colour saturation, and its phase corresponds to the hue.

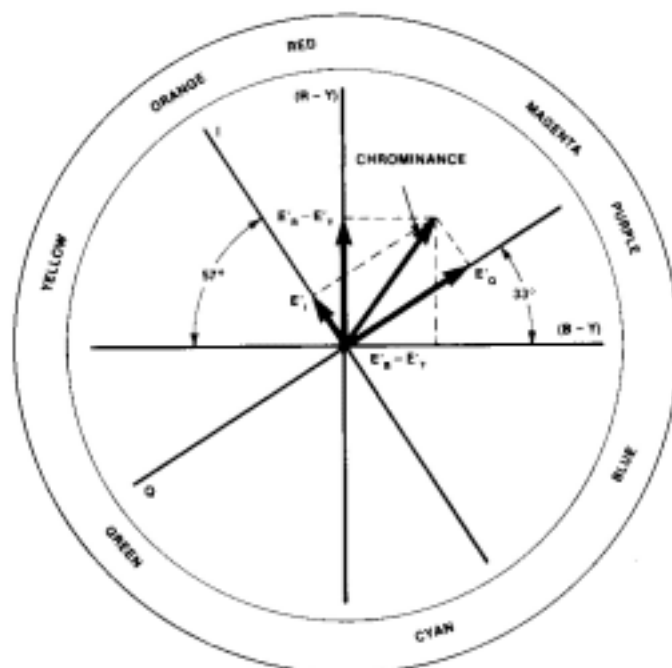

Lumiance, Chrominance, Saturation and Hue

The system was launched in the United States as early as 1954.

The first American equipment was very susceptible to hue errors caused by certain transmission conditions. European researchers tried to develop a more robust signal, less sensitive to phase distortions.

In 1961, **Henri de France**, put forward the SECAM system (Sequentiel Couleur à Memoire) in which the two chrominance components are transmitted in sequence, line after line, using frequency modulation. In the receiver, the information carried in each line is memorised until the next line has arrived, and then the two are processed together to give the complete colour information for each line.

In 1963, **Dr. Waite Bruch**, in Germany, proposed a variant of the NTSC system, known as PAL (Phase Alternation by Line). It differs from the NTSC system by the transmission of one of the chrominance components in opposite phase on successive lines, thus compensating the phase errors automatically.

Both solutions found application in the colour television services launched in 1967 in England, Germany and France, successively.

Digital television

The values of the brightness or colour of picture elements along a television line can be represented by a series of numbers. If these are expressed in base 2, each value can be transformed into a sequence of electrical pulses.

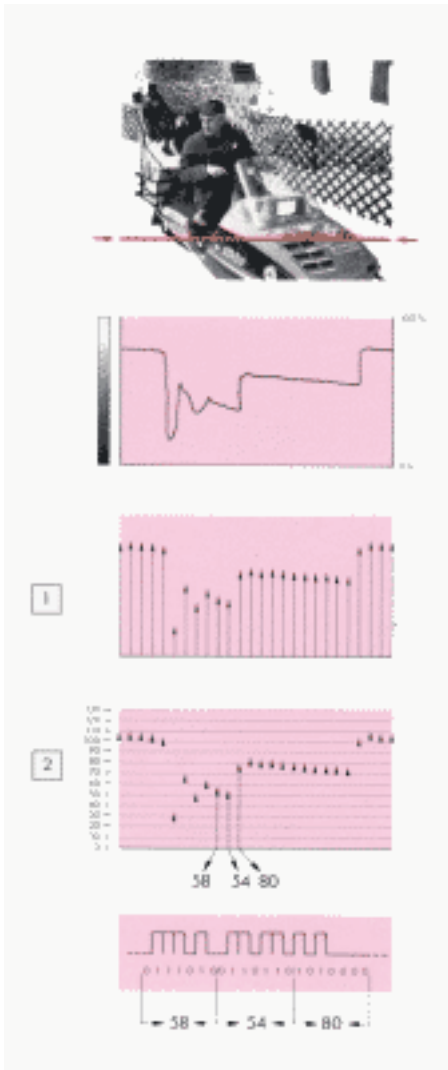

How digital sampling works

The operation which converts from the "analogue" world to the "digital" world comprises two stages:

- sampling in which the value is measured at regular intervals
- and quantification in which each measurement is converted into a binary number.

These operations are carried out by an analogue to digital converter.

The series of "1" and "0"s obtained after quantification can be modified (i.e. coded) to counteract more effectively the disturbances the signal will meet during transmission.

Digital television technology is an extension of computer and image processing technology. Advantages are easy storage and great scope for image processing.

Each picture element is isolated and can be called up independently according to varied and complex

Since the signal has only two possible values (0 or 1), detection is based on the presence or absence of the signal. Hence the possibility of regenerating it. Advantage: the signal can be preserved during successive recordings or on noisy transmission paths.

This technique is already in wide-spread use for special effects on existing images. It lies at the root of computerised image synthesis systems.

Technological developments

Television is a technology-based medium. It is the continual development of this technology and the associated facilities which has enabled producers and directors to overcome one after the other the limitations of the tools at their disposal and to offer an ever-greater challenge to the ingenuity of Man's imagination. Time spent reviewing these developments will be well rewarded.

Television cameras

The pick-up tube is the main element governing the technical quality of the picture obtained by the camera. The first electronic cameras using iconoscope tubes were characterised by very large lenses, necessary to ensure enough light reached the pick-up tube. These tubes developed rapidly, as the next section will show. The separation of the optical image from the electronic image gave the first improvement by allowing the target to be made smaller and enabling lenses to be used which had been designed originally for 16 and 35-mm motion-picture cameras.

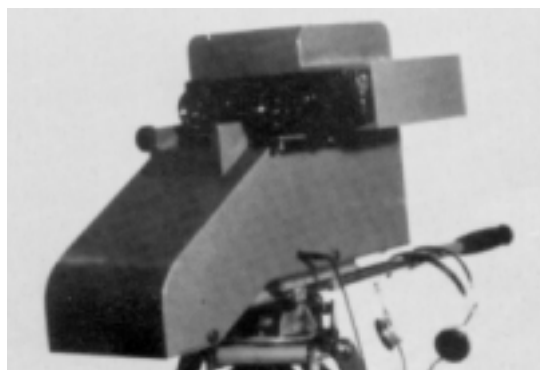

An early television camera (1937)



A modern television camera (1985)

When colour television arrived, cameras again became bulkier owing to the need to accommodate the three tubes for the three primary colours. The tubes of the 1950s, of the image-orthicon type, were far from ideal for the purpose. However in Europe the launch of colour services coincided with the arrival onto the market of the plumbicon tube and the few colour image-orthicon cameras in existence were rapidly put aside in favour of the new-comer. The bulk of the camera did not decrease, however, because more and more circuits were incorporated to improve the signal processing.

Camera tubes

The **iconoscope**, invented in 1929 by the American Viadimir Zworykin, is the ancestor of all television camera tubes.

The tube has a vacuum-tight glass envelope. At its centre is a dielectric plate (mica) one surface of which is coated with a thin uniform layer of metal, the other with a mosaic of thousands of tiny metal elements

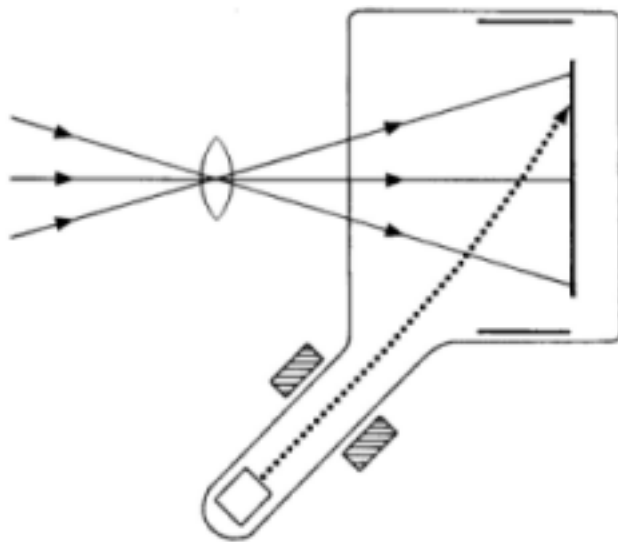

The iconoscope

which release electrons under the effect of illumination. The scene is focused onto this mosaic, which makes up a series of mini-condensators. An electron beam bombards these, one after the other. The amount of charge collected is proportional to the charge on each condensor, and therefore to the strength of illumination of each element.

When it hits the target, the scanning beam ejects so-called "secondary electrons" which form a cloud around the point of impact and blur the image.

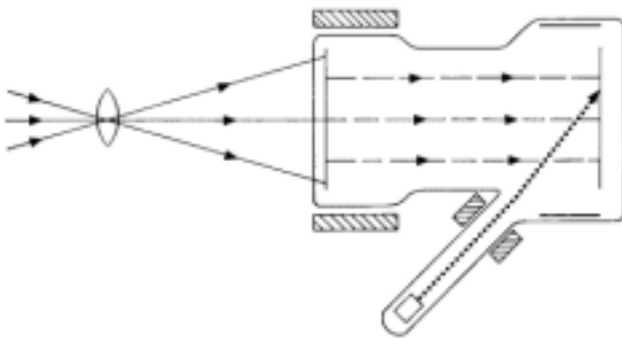

Super Iconoscope

The **super iconoscope**, invented in 1939, avoids this problem. In this tube the optical image is separated from the electronic image. The optical image falls on a transparent photoelectric surface and produces a stream of electrons which is focused on the mosaic scanned by the beam of electrons.

The **orthicon**, also invented in 1939, improves the scanning uniformity. The target is based on the same principle as the iconoscope (a mica sheet between a conducting surface and a photo-emissive surface) but the beam of electrons is aimed

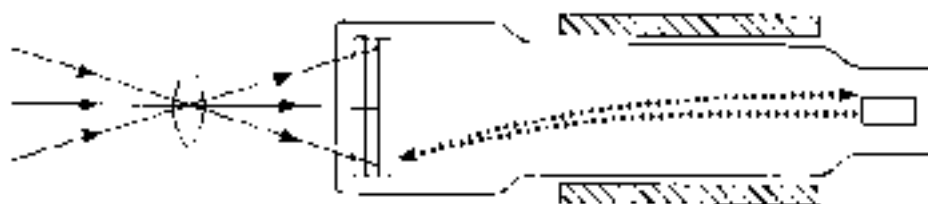

Orthicon

perpendicularly to the mosaic, which it hits at low speed. To allow the beam to arrive at the appropriate side of the mica sheet the conducting surface is transparent.

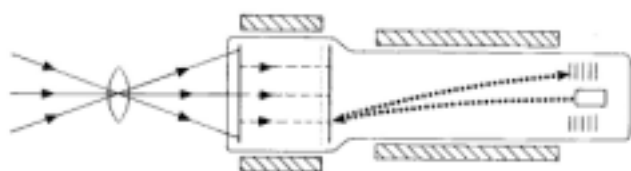
*Image Orthicon*

The **image-orthicon** dates from 1946. The photosensitive coating is not applied to the same medium as the target, but is separate. Under the effect of illumination, this coating releases electrons which are directed towards the target where secondary electrons are released. The resulting changes in electrical potential are transferred to the opposite side of the target where they are scanned by the electron beam from the cathode.

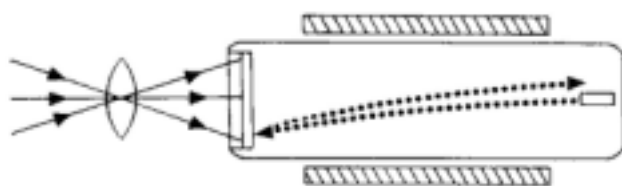
*The Vidicon*

The **Vidicon**, developed in 1951, uses a photo-conductive target rather than a photo-emissive one: a material whose electrical resistance varies according to the strength of illumination, is in direct contact with the metallic coating where the signal is produced. This layer is maintained at a positive voltage compared with the cathode but the photo-conductive material acts as a valve which allows, or prevents, the electrons to pass through, depending on the amount of light.

All modern tubes are variants of the Vidicon. Philips launched the **Plumbicon** in 1962 and Hitachi produced the **Saticon** in 1973. The main differences between those tubes are in the construction of their targets. The Plumbicon target contains lead oxide, whilst the Saticon target has selenium, arsenic and tellurium.

Camera lenses

The first cameras only had one lens. To increase the variety of scenes that could be televised a system was very soon devised in the form of a "turret" in front of the camera tube which carried several lenses of different focal lengths.

However, when the focal length is changed the plane in which the image is formed is shifted, so the cameraman has to adjust the focus. This inconvenience was eliminated with the invention of the continuously variable focal-length lens (zoom), and some of those now available cover focal-length ranges of more than 40:1. The most common zoom range used in the studio is about 15:1.

A typical zoom lens has some 30 glass elements, grouped in several sections and each serving a precise function.

A modern zoom lens

The operation of a zoom lens is based on a simple principle of optical science which determines that the smaller the focal length, the wider the angle of view. In other words, if the focal length is made to change smoothly, a progressive variation can be made from "wide-angle" to "tele photo " characteristics.

The zoom has at least two groups of lenses. One changes the image size A camera telecine as it moves whilst the other re-establishes correct focus. A single mechanism controls the movements of both lens groups, in a manner governed by the laws of optical geometry.

A zoom normally has an additional lens group at the front, adjustable over a limited range, and a rear group to fix the final image dimensions.

Television film scanning

Two types of equipment have been developed for the transmission of films on television: camera telecines and flying-spot telecines.

- In camera telecines [1], each film frame is focused onto the target of a television camera, via an appropriate lens system.
- In flying spot telecines [2], a light beam, produced on the screen of a cathode-ray tube, scans each film image line by line before activating a photoelectric cell.

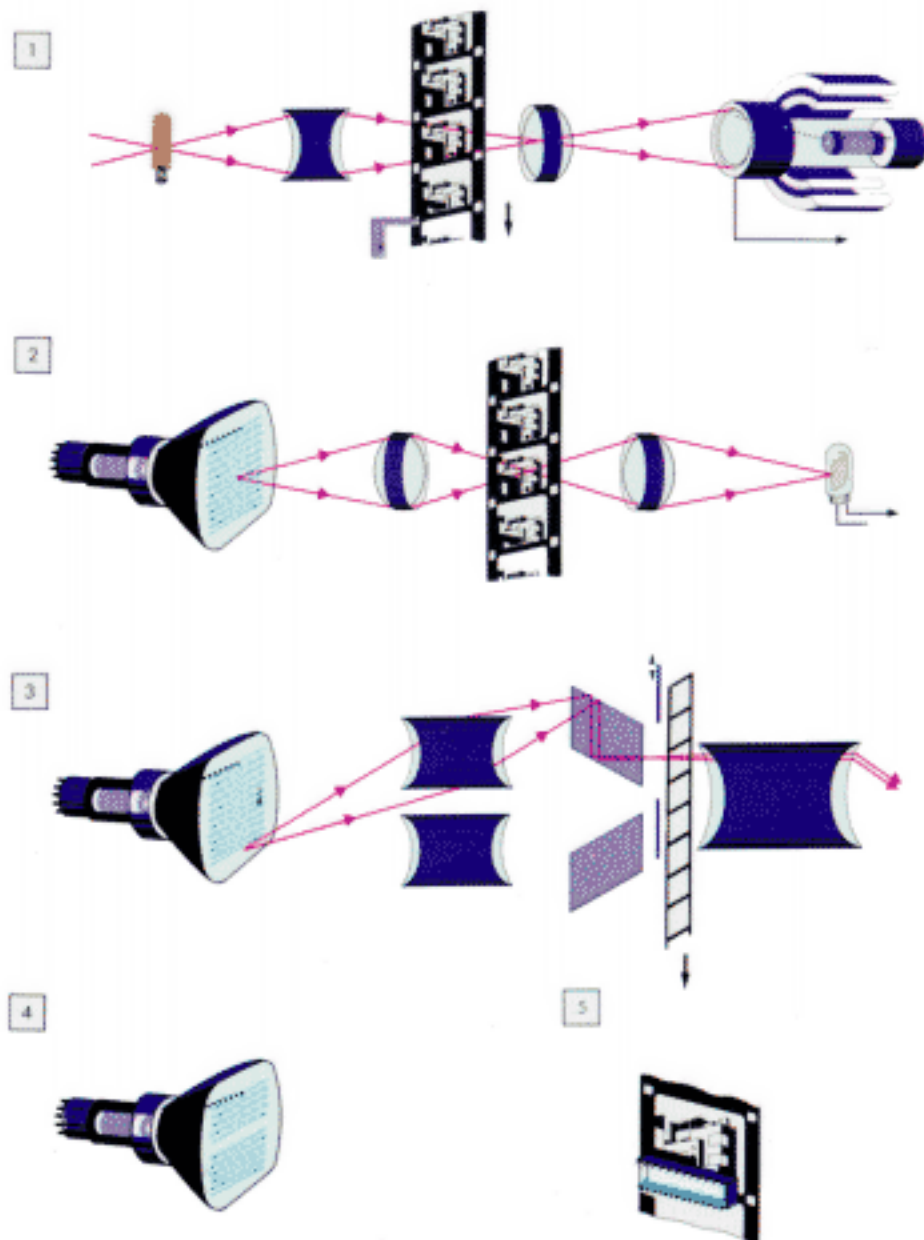

Telecines

Both types of telecines have been in use since the early days of television.

Each film frame has to be scanned twice to obtain two interlaced fields. For this purpose, the film in a camera telecine is held stationary for the duration of two fields.

With flying spot scanning, the arrangements most commonly used to produce the interlaced scanning pattern are twin lenses [3] and jump scan [4]. In the first case, a shutter covers one of the two lenses for the duration of one frame. With the second, it is the position of the scanning raster on the cathode-ray tube which periodically alternates.

A telecine using The use of semi-conductors led to a charge-coupled device the development of tubeless scanning systems [5]: an array of photosensitive sensors ("charge-coupled devices") collects the light beam moving through the film and variations in the illumination produce changes in electrical potential at the point of impact of the beam.

Video recording

In the early days, film was the only medium available for recording television programmes. Owing to the specific needs of American television networks, however (broadcasting at different times on the Atlantic and Pacific coasts) researchers were led to investigating more flexible systems.

Thoughts turned to magnetic tape, which was already being used for sound, but the greater quantity of information carried by the television signal demanded new studies. During the 1950s, a number of American companies began investigating the problem.

In April 1956, the Ampex company showed the first viable product. It recorded in black and white. Rivals RCA followed suit in 1957, with equipment designed for colour.

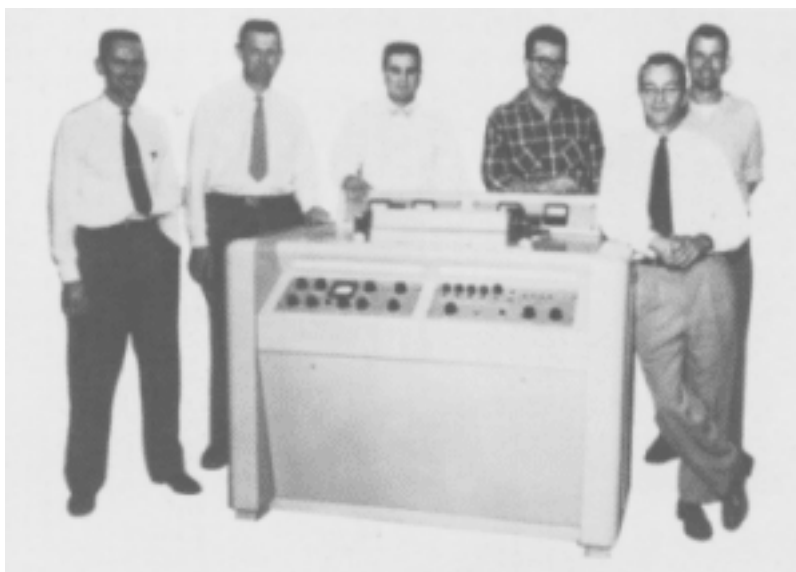

The first video tape recorder (Ampex, 1956) and the team that built it

The mechanical principle adopted was the same and was to remain in use for a long time. The system had four heads on a disc rotating perpendicularly across the width of the tape, thus tracing an oblique track pattern. The tape was 50.8 mm (2 inches) wide.

With the development of editing equipment, the initial "delayed broadcasting" function gradually gave way to "production" functions. The first all-electronic editing equipment avoiding the need for splicing tape was introduced in the late 1960s.

Slow-motion and variable-speed playback techniques were impossible with the "four

head " system. The situation changed with the advent of helical-scan video recorders (Toshiba, 1959) which at last provided editing facilities analogous to those of film.

Helical-scanning 0 is now used in all video recorders: each track contains one entire field (or a major part of it), and the tape can be "read" at different speeds, even when it is stationary. The magnetic tape is 25.4 mm (1 inch) wide.

In 1986 the first digital video cassette recorder meeting the international digital television standards was presented by the Sony company.

Electronic special effects

In television, it is possible to use electronic techniques (rather than chemical or optical techniques as in film production) to combine part of one image with part of another image. These electronic techniques are based on the use of a switch operated while the two images are being scanned. The switch is of course a very special one, extremely rapid and entirely electronic, although it is shown here as a simple mechanical device to make the drawing easier to understand.

The first of these techniques (inlay) was developed in 1953. The original feature of this method is that it uses a third image to divide up the available surface and redistribute it between the first two.

Timing of the electronic switch is adjusted by the variations in light along these boundaries. The process requires very strict control over the lighting conditions.

Towards the early 1970s, research began with systems in which the electronic switch is controlled by colour variations (hue and brightness).

This technique - known in television jargon as "chroma-key" - has since become one of the most widely used in colour television production.

Blue is often the colour used, as it can easily be avoided on people and sets, although other colours can also be used (orange or yellow for example) to contrast better with the chromatic composition of the scene.

The application of these processes can be repeated or combined, for example by recording a scene already containing special effects with the addition of a new one.

Digital images

The design of digital memories for recording television pictures has led to the development of image processing. The computer graphics artist at work systems offering far greater scope than conventional optical or electronic special effects techniques.

The image, translated into a series of separate elements, can be reconfigured and, for example, displaced on the screen, held or "frozen", deformed, compressed, extended, rotated or enlarged. All these digital effects are done using special computer

programming of the playback process.

Digital techniques can also be used purely to "manufacture" an image by electronic means: this is known as image synthesis or computer graphics.

Computerised image synthesis involves the use of algorithms to produce lines, curves, colour gradations or tones.

In the early systems (character generators), the required characteristics of individual image elements were stored in a memory and called up to constitute the image by juxtaposition.

In more recent systems, the memory also includes mathematical formulas so that a range of forms, structures and textures can be created. Such techniques are used in CAD (computer-aided design), but more complex equipment is needed in television, mainly because of requirements regarding moving images, special effects and aesthetic qualities (multiple reflections, shadows).

Towards other screens

Research is being pursued in several domains with a view to further improving the visual impression of electronic images.

High-definition television

Compared with present-day television technology, the differences would be as follows: wider image format (16:9), higher spatial resolution (about 1000 lines) larger viewing screens.

High-definition television would offer a quality comparable to that of 35-mm film and would therefore allow films to be shot electronically.

Stereoscopic television

No satisfactory method has yet been found for giving an impression of relief in television (3-D). One of the main problems is that systems relying on colour separation create an artificial impression. Researchers are today investigating techniques using neutral polarized glasses.

With all these systems, viewers would be required to wear glasses. To overcome this drawback, one of the long-term possibilities being explored is the design of picture tubes incorporating lenses that present images separately to the left and right eye.